

## Knowledge Organiser – Electricity (Science Year 6)

The flow of electrons in a circuit is known as a **current**.

Key Vocabulary	Definition
Terminal	Point of connection for closing an electric circuit.
Voltage	Force of an electrical current.
Current	Flow of electrical charge.
Resistance	Reducing the electric current flow through a material.

An electric current can only flow when there is a complete circuit.

Electrons are small particles with a negative electric charge.

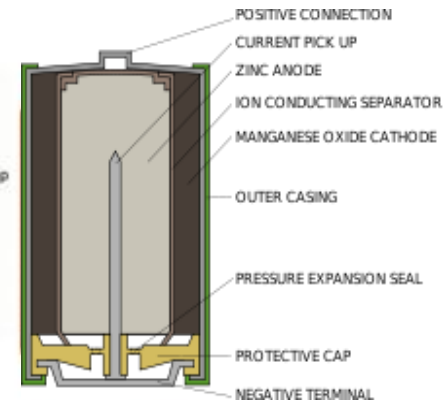
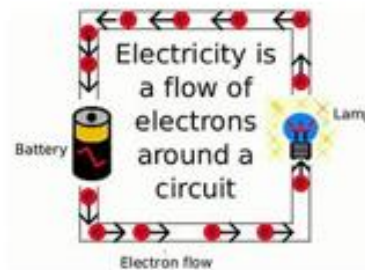

Batteries store **chemical energy** and change it to **electrical energy**.

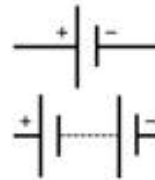

A **cell** is the basic unit that produces electricity, and a battery has two or more cells.

Voltage is the electrical force which causes electrons to flow around a circuit. It is measured in units called volts (V).

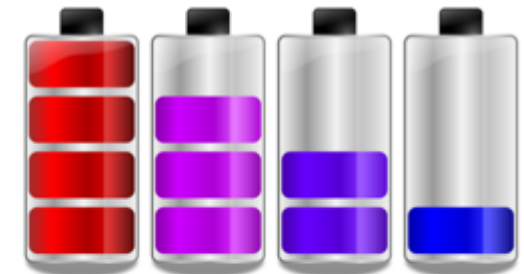

Increasing the battery voltage does two things:

- it increases the energy supplied.
- it drives the charge around the circuit at a greater rate.

A circuit connected in **series** contains components attached to each other, like holding hands in a circle.

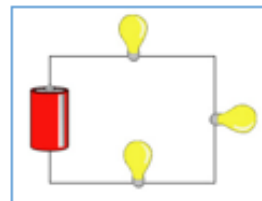

Components connected in a **parallel circuit** are connected across each other.

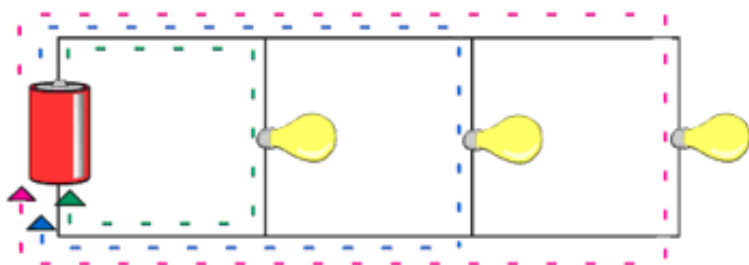

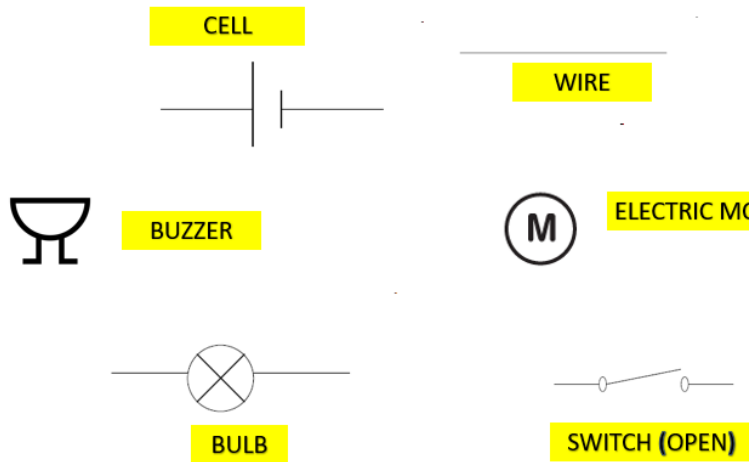

More batteries

Adding more batteries to a simple circuit will increase the electrical energy, which will make a bulb brighter.

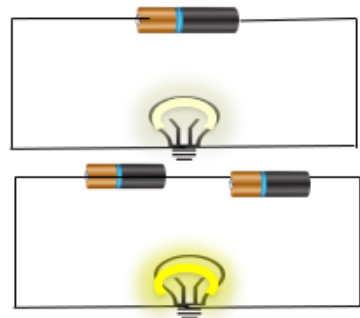

More bulbs

Adding more bulbs to a simple circuit will reduce the electrical energy and make the bulbs dimmer.

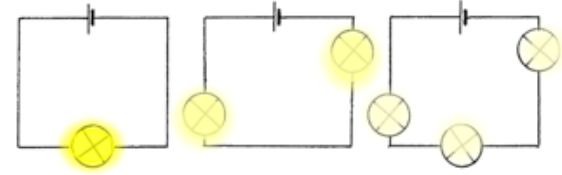

This diagram of a flow of traffic through a tollbooth can help explain the effect bulbs have in different types of circuit.

A bulb in the circuit slows down (resists) the flow of electricity.

The tollbooth represents the bulb and the cars imitate the flow of electricity.

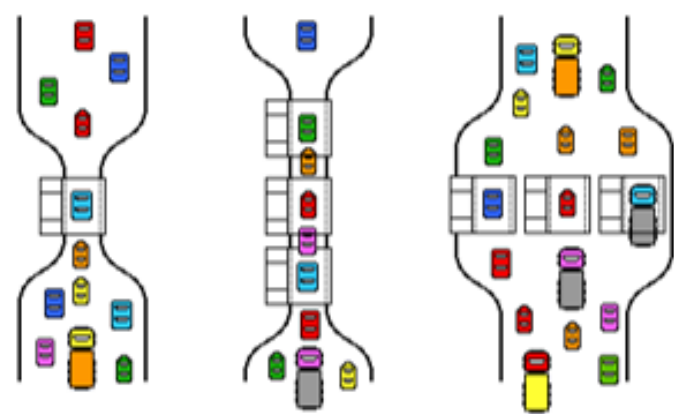

If the tollbooths (bulbs) were in parallel, there would be a greater flow of traffic (electricity) and the bulbs would be of equal brightness.

More tollbooths (bulbs) in series would slow down the flow of traffic even further so the bulbs would become dimmer.